

D-NAMIC

92 Shore A
+90°C
-40°C

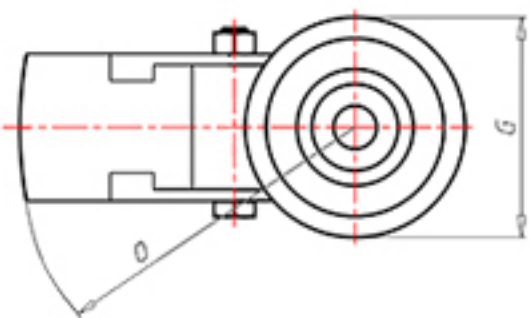

	D	150
	F	40
	H	181
	G	Ø 102
	C	Ø 16
	E	52
	O	124
	LC	350

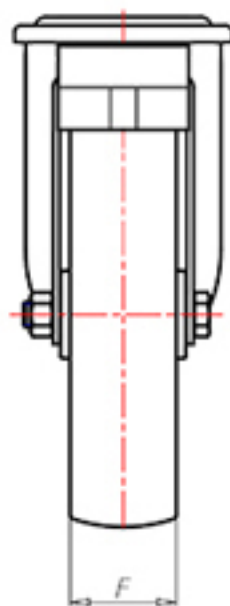
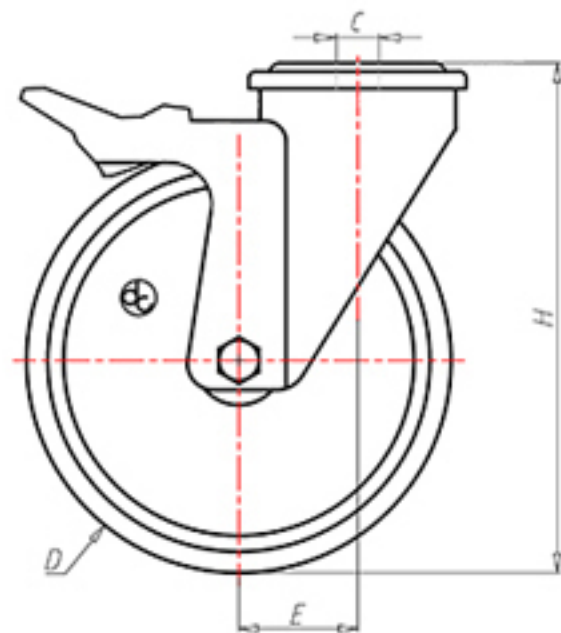

Code for plain bore wheel

XNPZ15060FA



Code for wheel with roller bearing

XNPZ15060RFA



Code for wheel with double sealed ball bearing

XNPZ15060CFA



Code for wheel with double sealed Inox ball bearing

-

