

D-NAMIC

92 Shore A
+90°C
-40°C

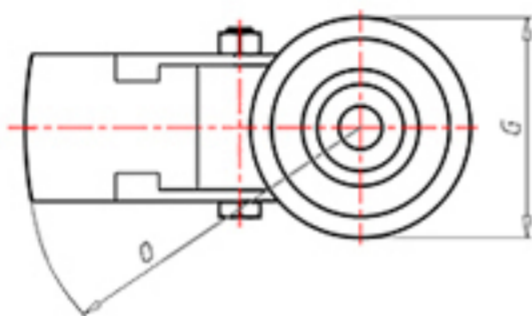

	D	80
	F	33
	H	108
	G	Ø 77
	C	Ø 12
	E	40
	O	124
	LC	200

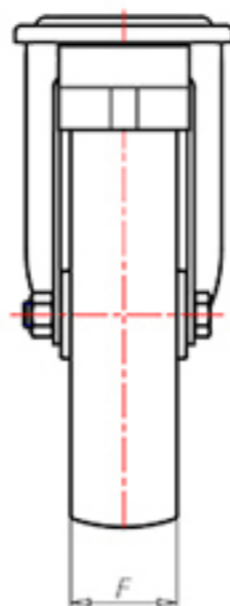
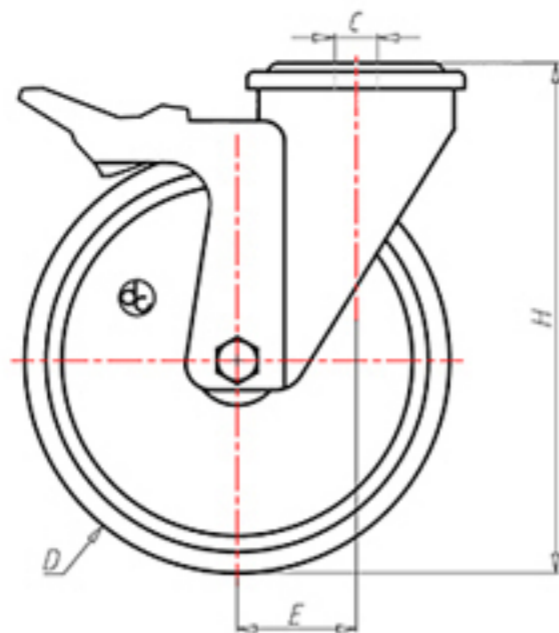

Code for plain bore wheel

XNPZ8040FA



Code for wheel with roller bearing

XNPZ8040RFA



Code for wheel with double sealed ball bearing

XNPZ8040CFA



Code for wheel with double sealed Inox ball bearing

-

