

D-FLEX

82 Shore A  
+90°C  
-40°C

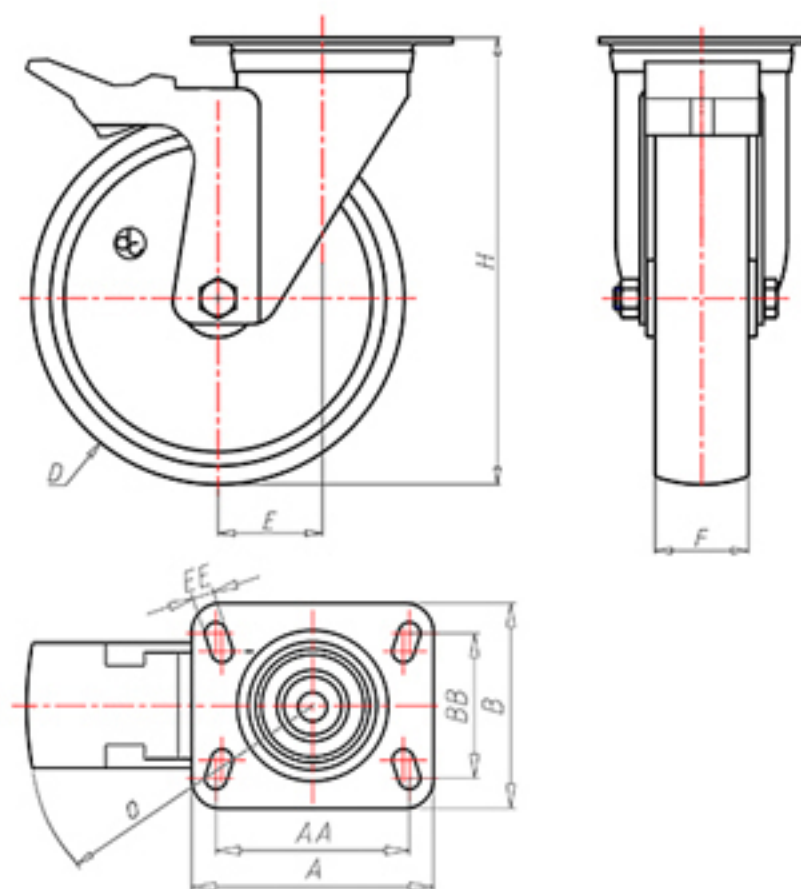

	D	100
	F	33
	H	128
	AxB	100x85
	AAxBB	80x60
	EE	9
	E	42
	O	124
	LC	220



Code for plain bore wheel

XSGZ10040FA



Code for wheel with Inox roller bearing

XSGZ10040RFA



Code for wheel with double sealed ball bearing

XSGZ10040CFA



Code for wheel with double sealed Inox ball bearing

-

