

D-FLEX

82 Shore A
+90°C
-40°C

INOX

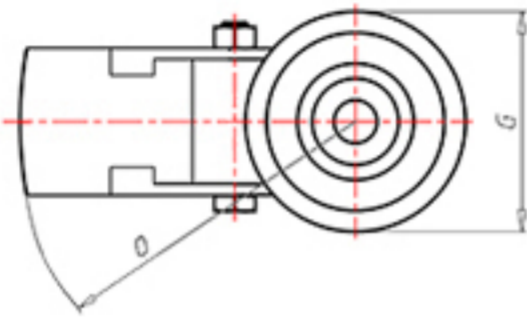
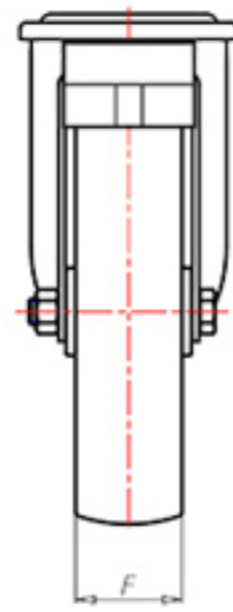
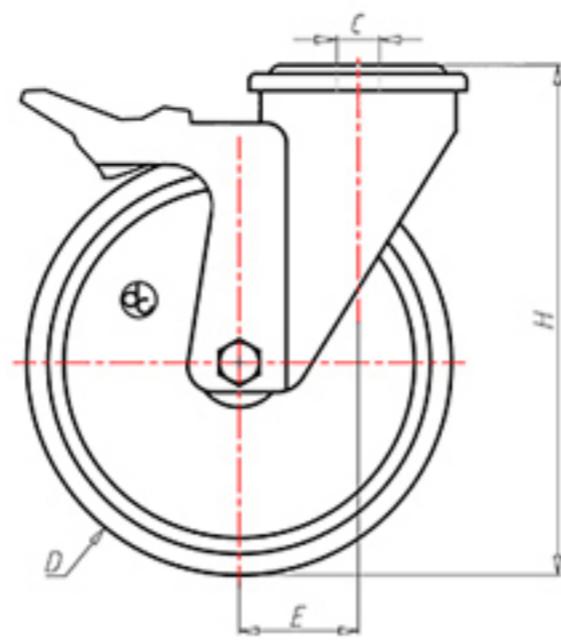

	D	100
	F	33
	H	128
	G	Ø 77
	C	Ø 12
	E	42
	O	124
	LC	220



Code for plain bore wheel

XSPX10040FA



Code for wheel with Inox roller bearing

XSPX10040RXFA



Code for wheel with double sealed ball bearing

XSPX10040CFA



Code for wheel with double sealed Inox ball bearing

XSPX10040CXFA

