

D-FLEX

82 Shore A
+90°C
-40°C

INOX

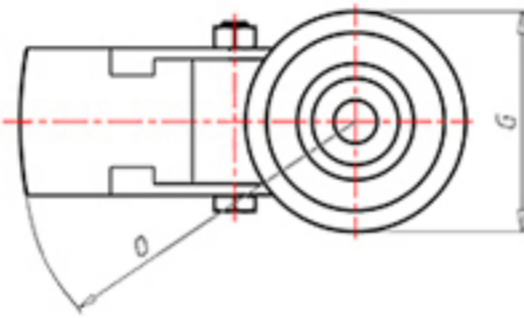
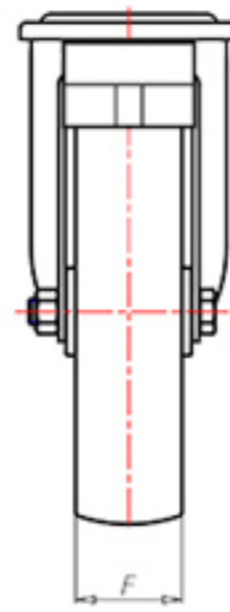
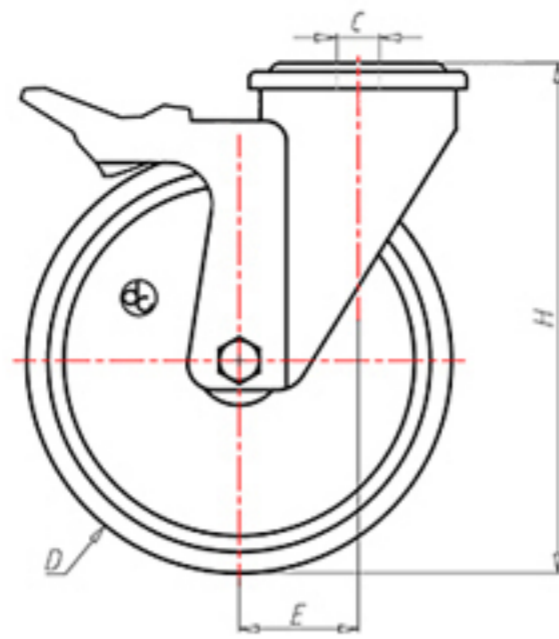

	D	100
	F	33
	H	128
	G	Ø 77
	C	Ø 12
	E	42
	O	124
	LC	220



Code for plain bore wheel

XSPX10045FA



Code for wheel with Inox roller bearing

XSPX10045RXFA



Code for wheel with double sealed ball bearing

XSPX100CFA



Code for wheel with double sealed Inox ball bearing

XSPX100CXFA

