

D-FLEX

82 Shore A
+90°C
-40°C

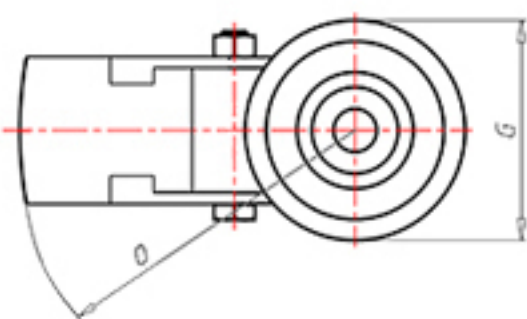

	D	100
	F	33
	H	128
	G	Ø 77
	C	Ø 12
	E	42
	O	124
	LC	220

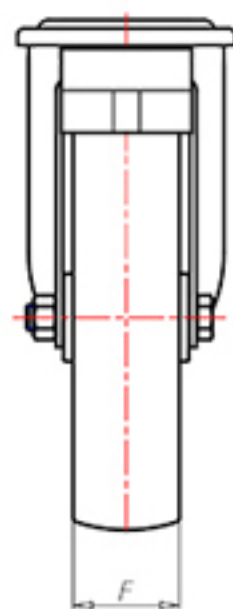
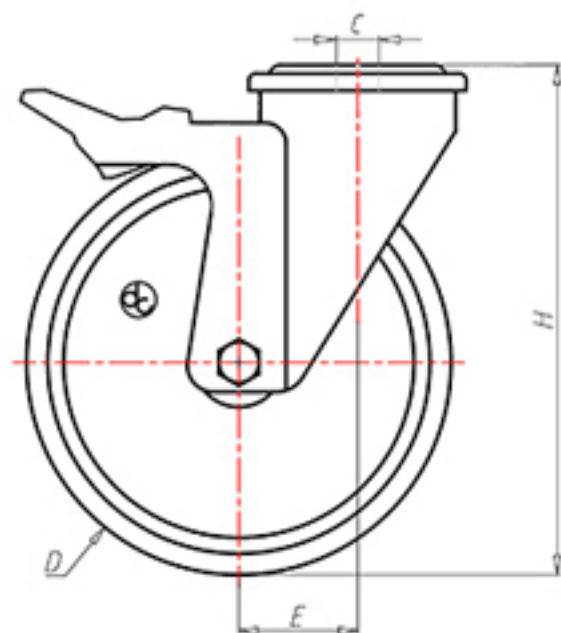

Code for plain bore wheel

XSPZ10045FA



Code for wheel with roller bearing

XSPZ10045RFA



Code for wheel with double sealed ball bearing

XSPZ100CFA



Code for wheel with double sealed Inox ball bearing

-

