

D-FLEX

82 Shore A  
+90°C  
-40°C

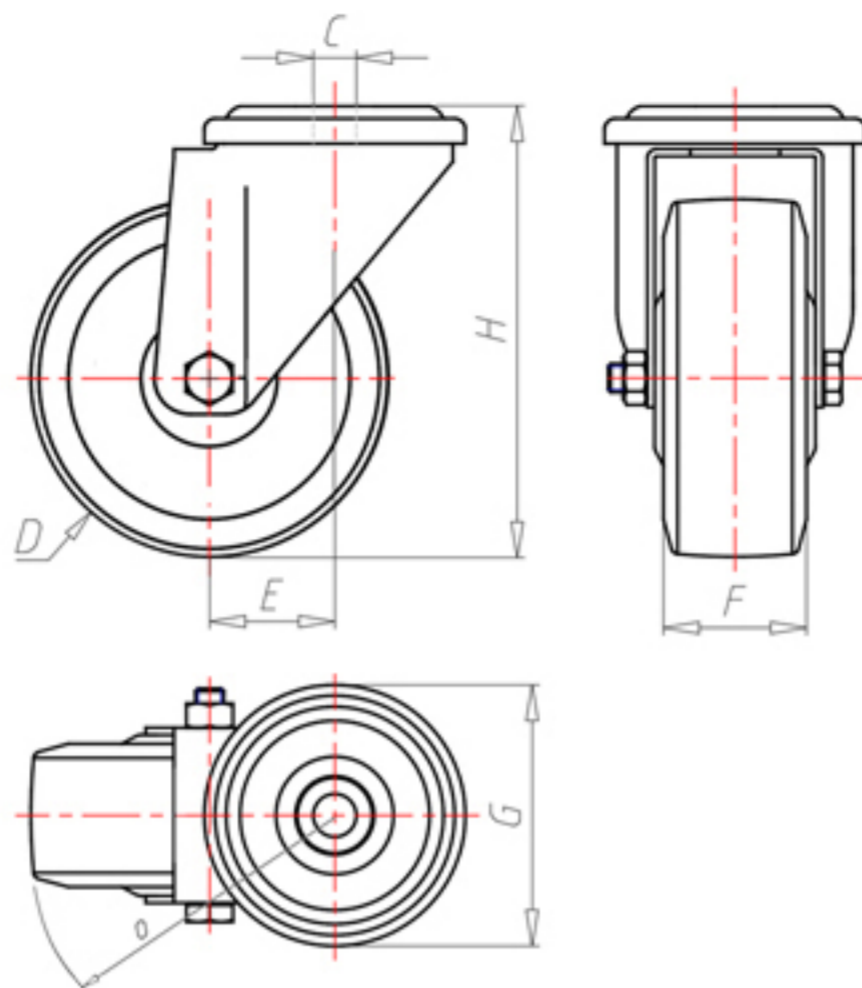

	D	80
	F	33
	H	108
	G	Ø 77
	C	Ø 12
	E	40
	O	82
	LC	200



Code for plain bore wheel

XSPZ8040



Code for wheel with roller bearing

XSPZ8040R



Code for wheel with double sealed ball bearing

XSPZ8040C



Code for wheel with double sealed Inox ball bearing

-

